



3GHD-OE-SFP

SD/HD/3G-SDI optical to electrical converter
with SFP

User manual

Rev. A

A large, solid green circular graphic with a white circular cutout in the center, located in the bottom right corner of the page.

Nevion
Nordre Kullerød 1
3241 Sandefjord
Norway
Tel: +47 33 48 99 99
neviON.com

Neveion Support

Neveion Europe

P.O. Box 1020
3204 Sandefjord, Norway
Support phone 1: +47 33 48 99 97
Support phone 2: +47 90 60 99 99

Neveion USA

1600 Emerson Avenue
Oxnard, CA 93033, USA
Toll free North America: (866) 515-0811
Outside North America: +1 (805) 247-8560

E-mail: support@neveion.com

See <http://www.neveion.com/support/> for service hours for customer support globally.

Revision history

Current revision of this document is the uppermost in the table below.

Rev.	Repl.	Date	Sign	Change description
A	-	2015-12-02	BA	Initial document

Contents

Revision history	2
1 Product overview	4
2 Specifications	5
2.1 General	5
2.2 Optical Inputs	5
2.3 Electrical Outputs	5
2.4 Standards.....	5
3 Configuration	6
3.1 Multicon Gyda configuration	6
3.2 Configuration through DIP settings.....	6
3.2.1 Re-clocker mode	7
3.2.2 Display optical input power	7
3.2.3 Configuration example	8
4 Connections	9
4.1 Mounting the connector module	10
4.2 Terminal format support	10
5 Operation.....	11
5.1 Module status.....	11
5.1.1 Multicon Gyda status interface	11
5.2 GPI ALARM – Module Status Outputs.....	12
5.2.1 GPI connections.....	12
5.3 Front panel – Status monitoring	13
General environmental requirements for Neviaon equipment	14
Product Warranty.....	15
Appendix A Materials declaration and recycling information	16
A.1 Materials declaration.....	16
A.2 Recycling information.....	16

1 Product overview

The Flashlink 3GHD-OE-SFP is a single channel multibit-rate optical to electrical converter module providing high performance media conversion for various signal formats from 19.4Mbps up to 2970Mbps. Unmatched signal accuracy, even in critical applications with pathological signal patterns makes the 3GHD-OE-SFP the first choice for all optical transport demands.

The 3GHD-OE-SFP can transport all SD, HD and 3G signal formats in addition to DVB-ASI and SMPTE310M. It performs optical refreshing and signal re-clocking, which is selectable on application. The optical inputs is embedded in optional SFP module, which makes the module configurable to application specific needs. The open system platform of Nevision Flashlink system allows easy interoperability with third party fiber optical systems.

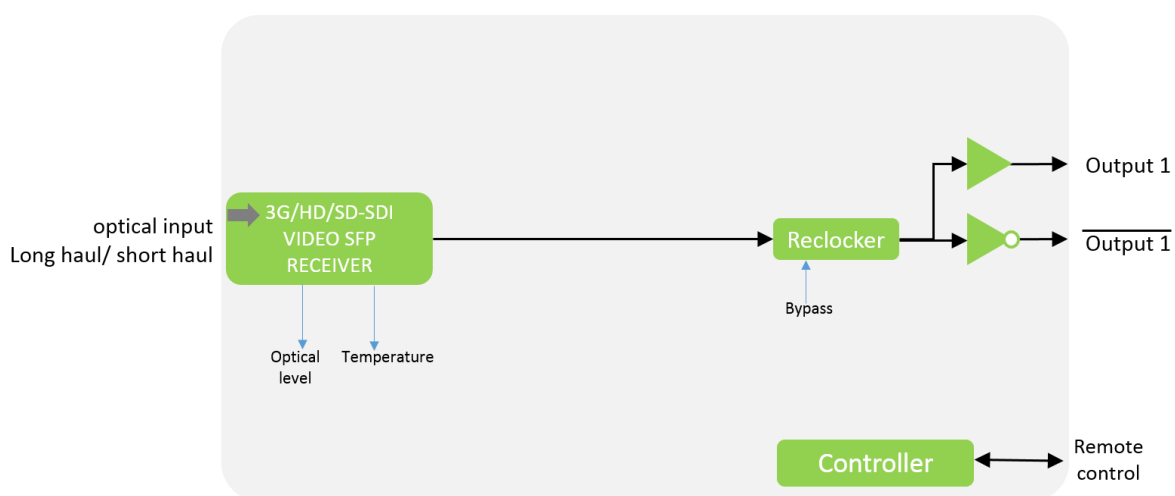

Figure 1 Block diagram of the 3GHD-OE-SFP

2 Specifications

2.1 General

Power	+5V DC / 1.0W, maximum without SFP +5V DC / 2.0W maximum with dual SFP
Control	Control system for access to setup and module status with BITE (Built-In Test Equipment)
Temp. range	0 to +40 °C

2.2 Optical Inputs

Number of inputs	1
Transmission circuit fiber	Single mode 9/125um
Connector	SC/UPC, single mode
Optical wavelength	~1260-1620nm
Optical sensitivity	See manual for installed SFP
Optical overload	See manual for installed SFP
Detector damage threshold	See manual for installed SFP

2.3 Electrical Outputs

Number of outputs	2
Connector	BNC
Impedance	75 ohm
Return loss	>15dB @ 5-1485MHz >10dB 1485-2970MHz
Peak to peak signal level	800mV +/- 10%
Signal polarity	1 inverting, 1 non-inverting

2.4 Standards

Supported standards for electrical and optical ports:

SMPTE292M, SMPTE259M, SMPTE297M, SMPTE305.2M, SMPTE310M, SMPTE424M, DVB-ASI EN50083-9.

3 Configuration

Configuration of this card can either be done from Multicon Gyda element manager or locally on the card by dipswitches.

3.1 Multicon Gyda configuration

Below is a snapshot from the Multicon Gyda interface. In order to control the unit via Multicon Gyda, DIP 8 has to be switched OFF.

3GHD SFP OE converter

Card label: Locate card sec

Firmware upgrade: Upload file: Upload

Reclocker: Enable Bypass Autobypass: On Off

Alarm	Lower limit	Upper limit	Alarm	SNMP trap
Optical input			<input checked="" type="radio"/> Normal <input type="radio"/> Ignore	<input type="radio"/> Send <input checked="" type="radio"/> Ignore
Voltage (5.0V)	4500 mV	5500 mV	<input checked="" type="radio"/> Normal <input type="radio"/> Ignore	<input type="radio"/> Send <input checked="" type="radio"/> Ignore
Voltage (3.3V)	3000 mV	3600 mV	<input checked="" type="radio"/> Normal <input type="radio"/> Ignore	<input type="radio"/> Send <input checked="" type="radio"/> Ignore
Reclocker			<input checked="" type="radio"/> Normal <input type="radio"/> Ignore	<input type="radio"/> Send <input checked="" type="radio"/> Ignore

Card version

Serial	0371809250200831
hw	1.1
lib	1.2.100
sfp	18793
sw	1.1.20

Figure 2 Configuration tab

3.2 Configuration through DIP settings

The 3GHD-OE-SFP can support a number of different broadcast formats. The correct configuration can either be set with the two Dipswitches on the card or through the GYDA Control System. The layout is shown in the drawing below with the DIP switches to the upper left position.

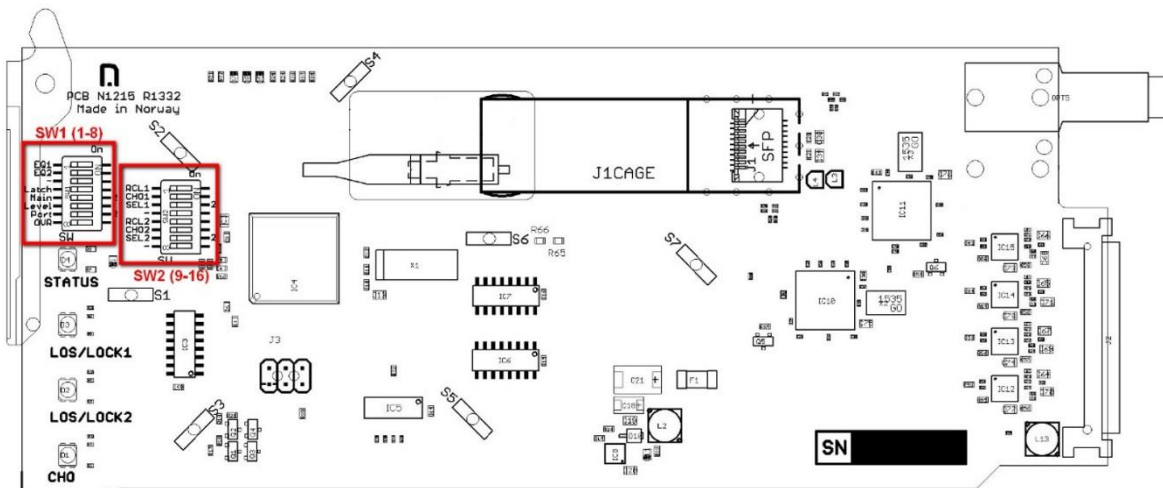

Figure 3 3GHD-OE-SFP board layout

Table 1: DIP settings.

Switch #	Label	Function, DIP=OFF	Function, DIP=ON	Comment
1	EQ1			Not used
2	EQ2			Not used
3				Not used
4	Latch			Not used
5	Main			Not used
6	Level	LED's normal operation	All LED's showing optical input power	DOP See Table 2 Displaying optical input power
7	Port			Not used
8	OVR	GYDA control. Configuration with GYDA	Override GYDA control. Configuration with DIP switch	Select configuration from GYDA
9	RCL1	Reclocker 1 bypass	Reclocker 1 enabled	Sets reclocker mode for output 1
10	CHO1			Not used
11	SEL1			Not used
12				Not used
13	RCL2			Not used
14	CHO2			Not used
15	SEL2			Not used
16				Not used

All DIP switches are off when pointing towards the release handle.

3.2.1 Re-clocker mode

The re-clocker can be set to re-clock or bypass from DIP#9 or from GYDA.

When re-clocker is set to re-clock mode jitter from signal is removed. Accepted bitrates is 270, 1483.5, 1485, 2967 and 2970Mbps.

When re-clocker is set to bypass the converter accepts all bitrates between 2 to 2970Mbps. Note that in this mode the jitter is not removed and this can cause problems for equipment following the converter.

3.2.2 Display optical input power

The LED's can be used as an optical power meter. This is practical under installation of the module. The power measurement is not accurate but can be used as an indication of optical power strength. Remember to turn this function off after installation. When all LEDs are green the optical input power is more than -6.5dBm. When all LEDs are off input power is below -25dBm.

The DOP (Display of Optical input Power) can only be turned on from the DIP. DOP is turned on by DIP#6.

Table 2 Displaying optical input power

Optical input power	Status LED	LOS/lock1 LED	LOS/lock2 LED	CHO LED
More than -6.5dBm	Green	Green	Green	Green
-7.0dBm to -8.5dBm	Yellow	Green	Green	Green
-9.0dBm to -10.5dBm	Red	Green	Green	Green
-11.0dBm to -12.5dBm		Green	Green	Green
-13.0dBm to -14.5dBm		Yellow	Green	Green
-15.0dBm to -16.5dBm		Red	Green	Green
-17.0dBm to -18.0dBm			Green	Green
-18.5dBm to -19.0dBm			Yellow	Green
-19.5dBm to -20.0dBm			Red	Green
-21.0dBm to -22.0dBm				Green
-23.0dBm to -24.0dBm				Yellow
Below -25dBm				Red

3.2.3 Configuration example

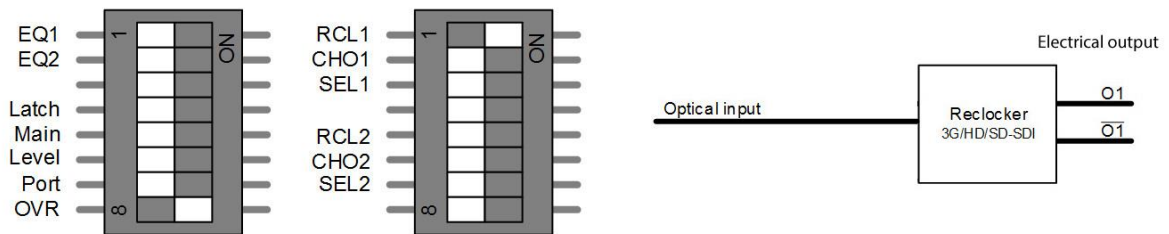

Figure 4 OE converter with Reclocker ON

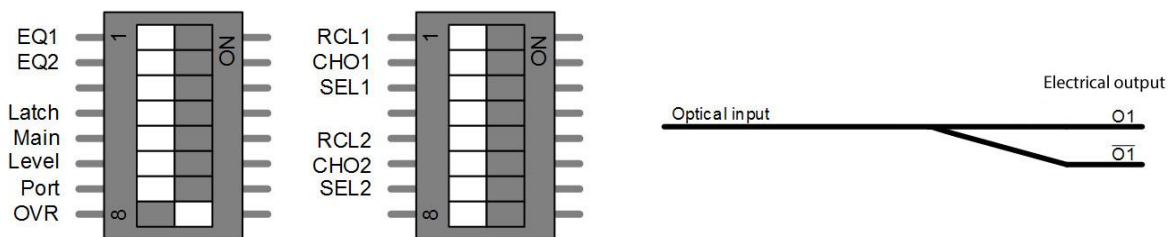

Figure 5 OE converter with Reclocker in bypass

4 Connections

The 3GHD-OE-2-SFP has a dedicated connector module; 3GHD-OE-C1-SFP. This module is mounted at the rear of the sub-rack. The layout of the module is shown in the figure below.



Figure 6 Connector module for 3GHD-OE-SFP

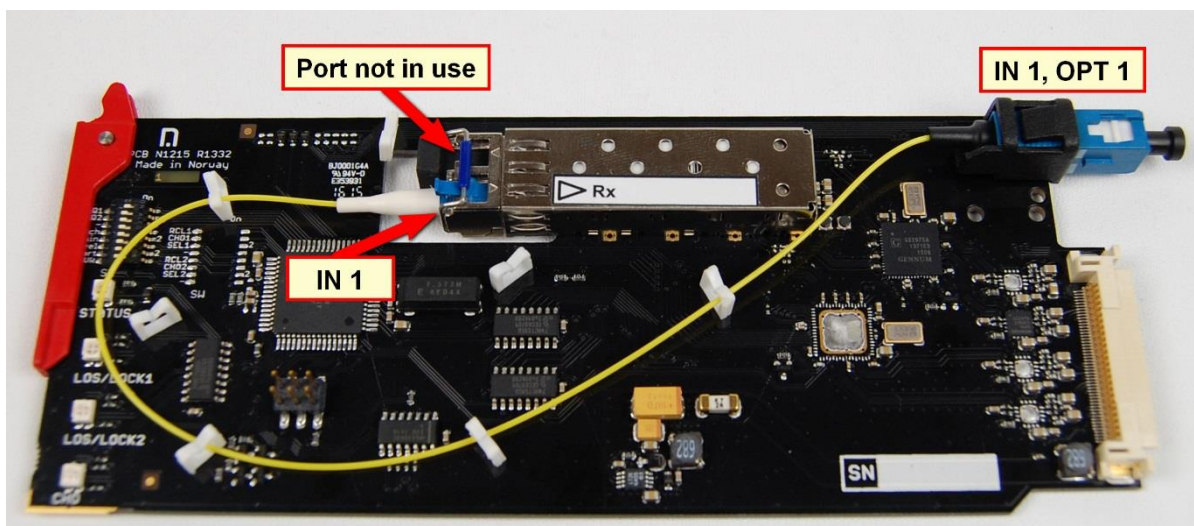

Figure 7 Fiber layout

4.1 Mounting the connector module

The details of how the connector module is mounted, is found in the user manual for the sub-rack frame FR-2RU-10-2.

This manual is also available from our web site: <http://www.nevion.com>

4.2 Terminal format support

The input and output ports on 3GHD-OE-SFP can support a number of formats. The table below show which signal formats are supported on the selected terminals.

Table 3 Signal support

Terminal	Function	Supported Format	Mode
OPT1	Optical input	SDI, DVB-ASI, SMPTE310, Transparent	Input
O1	Electrical Output Reclocked DA output	SDI, DVB-ASI, Transparent	Output
$\overline{O1}$	Electrical Output Reclocked DA inverted output	SDI, Transparent	Output
GPI ALARM	Open Collector Alarms	Wired alarms	OC Output

5 Operation

5.1 Module status

The status of the module can be monitored in three ways.

1. GYDA System Controller (optional).
2. GPI at the rear of the sub-rack.
3. LED's at the front of the sub-rack.

Of these three, the GPI and the LED's are mounted on the module itself, whereas the GYDA System Controller is a separate module giving detailed information on the card status.

5.1.1 Multicon Gyda status interface

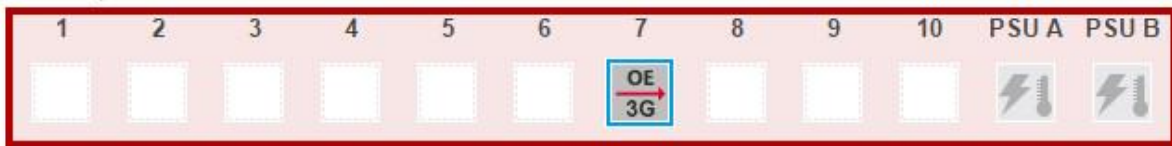

3GHD SFP OE converter



Optical input	Signal detected	-18.2 dBm
Reclocker	Locked	2970 Mbps HD
Voltage (5.0V)	5.22 V	
Voltage (3.3V)	3.34 V	
SFP Temp	34.0 C	

Alarms		
Optical input	RESTORED	Acknowledge
Reclocker	RESTORED	Acknowledge
Card lost	RESTORED	Acknowledge
Acknowledge all. 3 alarms	COMMON	Ack all

Figure 8 Status tab in Multicon Gyda

The on-board temperature measurement is a feature used for monitoring variations in temperature over time and can be accessed thru SNMP. The absolute value of the temperature measurement has little value of its own as it does not reflect the temperature inside the electronics nor the ambient frame temperature.

5.2 GPI ALARM – Module Status Outputs

These outputs can be used for wiring up alarms for third party control systems. The GPI outputs are open collector outputs, sinking to ground when activated. The GPI connector is shown in figures below.

Electrical maximums for GPI outputs:

Max current: 100mA

Max voltage: 30V

5.2.1 GPI connections

3GHD-OE-SFP module GPI pinning:

Signal	Name	Pin #	Mode
Status	General error status for the module.	Pin 1	Open Collector This is normally closed.
LOS1	Loss of signal on input 1.	Pin 2	Open Collector
Ground	0V / gnd pin.	Pin 8	0V.

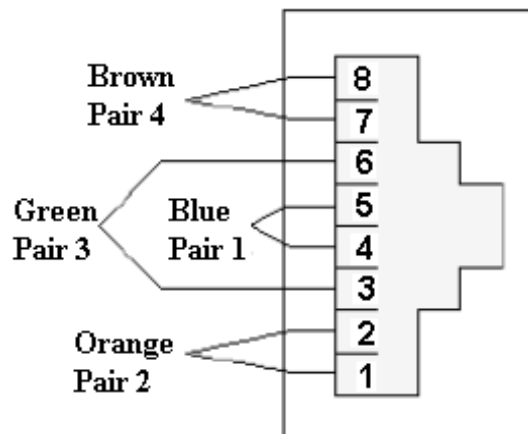

Figure 9 GPI connector

5.3 Front panel – Status monitoring

The status of the module can be easily monitored visually by the LED's at the front of the module. The LED's are visible through the front panel as shown in the figure below.

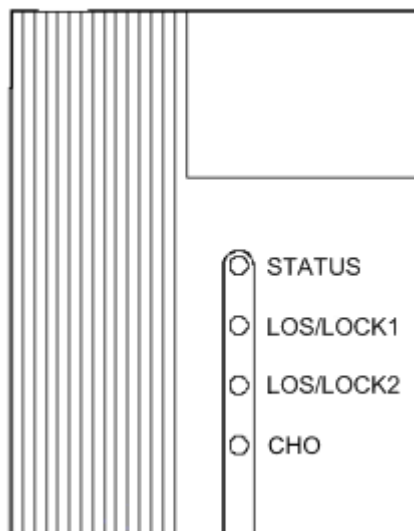

Figure 10 Front panel LED's

The 3GHD-OE-SFP has 2 LED's each showing a status corresponding to the GPI pinning. When DIP#6 is on, All 4 LED's are used as an optical power meter as seen in Table 2.

Table 4 Front panel LED's

Diode \ State	Red LED	Yellow LED	Green LED	No light
Status	Module is faulty, or module is initializing.	SFP failure or absent.	Module is OK Module power is OK	Module has no power
LOS/LOCK1	No input signal on electrical output 1.	Input signal on electrical output 1 but reclocker not in lock.	Input signal on electrical output 1 and reclocker in lock.	
LOS/LOCK2	Only used as optical power meter as seen in Table 2.			
CHO	Only used as optical power meter as seen in Table 2.			

General environmental requirements for Nevia equipment

1. The equipment will meet the guaranteed performance specification under the following environmental conditions:
 - Operating room temperature range: 0°C to 45°C
 - Operating relative humidity range: <90% (non-condensing)

2. The equipment will operate without damage under the following environmental conditions:
 - Temperature range: -10°C to 55°C
 - Relative humidity range: <95% (non-condensing)

Product Warranty

The warranty terms and conditions for the product(s) covered by this manual follow the General Sales Conditions by Nevion, which are available on the company web site:

www.nevion.com

Appendix A Materials declaration and recycling information

A.1 Materials declaration

For product sold into China after 1st March 2007, we comply with the “Administrative Measure on the Control of Pollution by Electronic Information Products”. In the first stage of this legislation, content of six hazardous materials has to be declared. The table below shows the required information.

組成名稱 Part Name	Toxic or hazardous substances and elements					
	鉛 Lead (Pb)	汞 Mercury (Hg)	鎘 Cadmium (Cd)	六价铬 Hexavalent Chromium (Cr(VI))	多溴联苯 Polybrominated biphenyls (PBB)	多溴二苯醚 Polybrominated diphenyl ethers (PBDE)
3GHD-OE-SFP	○	○	○	○	○	○

O: Indicates that this toxic or hazardous substance contained in all of the homogeneous materials for this part is below the limit requirement in SJ/T11363-2006.

X: Indicates that this toxic or hazardous substance contained in at least one of the homogeneous materials used for this part is above the limit requirement in SJ/T11363-2006.

This is indicated by the product marking:



A.2 Recycling information

Nevion provides assistance to customers and recyclers through our web site <http://www.nevion.com/>. Please contact Nevion’s Customer Support for assistance with recycling if this site does not show the information you require.

Where it is not possible to return the product to Nevion or its agents for recycling, the following general information may be of assistance:

- Before attempting disassembly, ensure the product is completely disconnected from power and signal connections.
- All major parts are marked or labeled to show their material content.
- Depending on the date of manufacture, this product may contain lead in solder.
- Some circuit boards may contain battery-backed memory devices.